

ZDPM 25/10

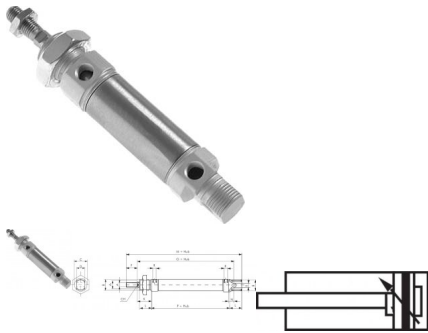

ISO 6432 cylinder, dubbelverkande, kolv Ø 25 mm, slag 10mm. Magnetkolv. Justerbar ändlägesdämpning.

Betyg: Inte betygsatt ännu

Pris

Pris 1.020,49 kr

Pris utan moms 816,39 kr

Rabatt

Momsbelopp 204,10 kr

[Ställ en fråga om denna produkt](#)

Beskrivning

Technical data

Piston Ø [mm] Piston Ø 25 mm

Stroke [mm] 10

Equipment adjustable end position damping, magnetic piston

A M 10 x 1.25

A1 [mm] 10

B M 22 x 1.5

C [mm] 30

D [mm] 16

E [mm] 8

F [mm] 22

G [mm] 104

K [mm] 28

L [mm] 22

M [mm] 140

N [mm] 12

P [mm] 68

R G 1/8"

CH [mm] 9

Weight 250 g / pc.